

CLICK IT SPOT 22W

Installation Manual

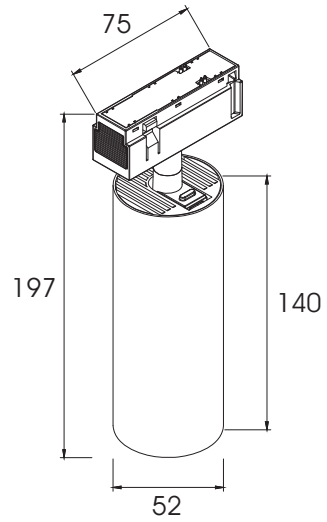

1



Attention
Switch off the main power.

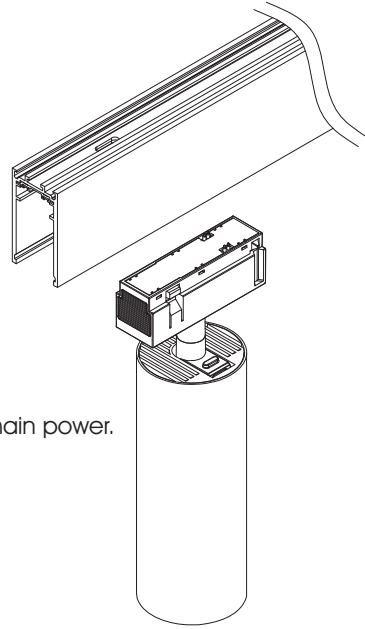
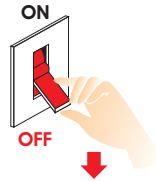

2

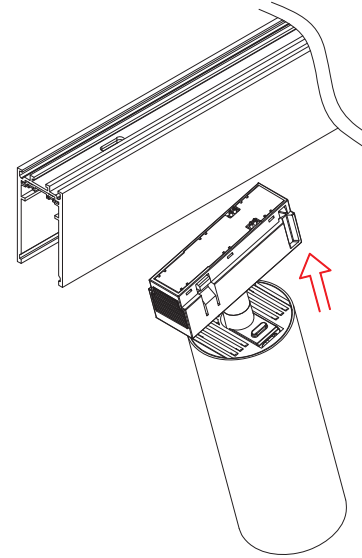

3

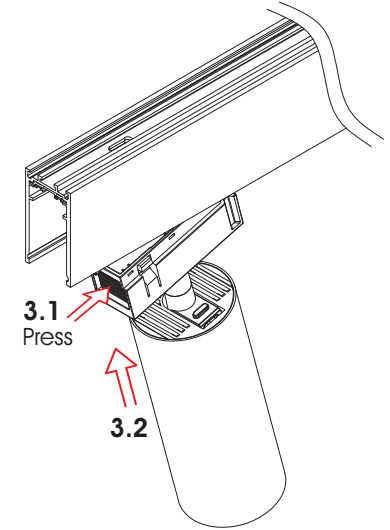

4

Be sure that the click button is not pressed

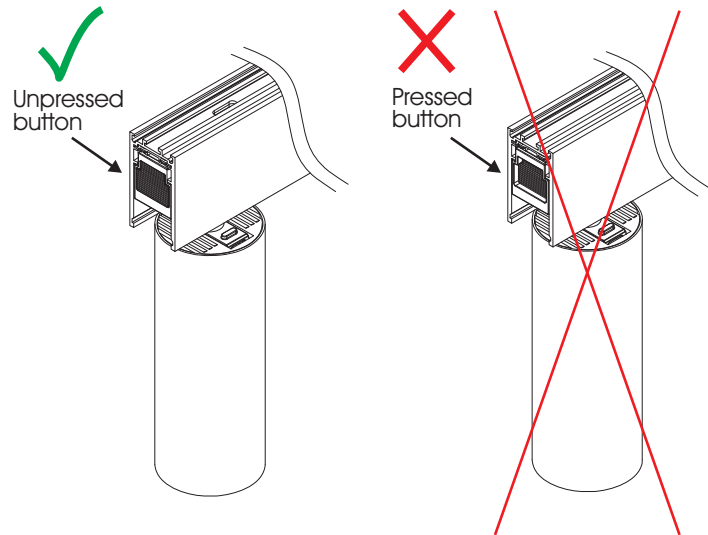

5

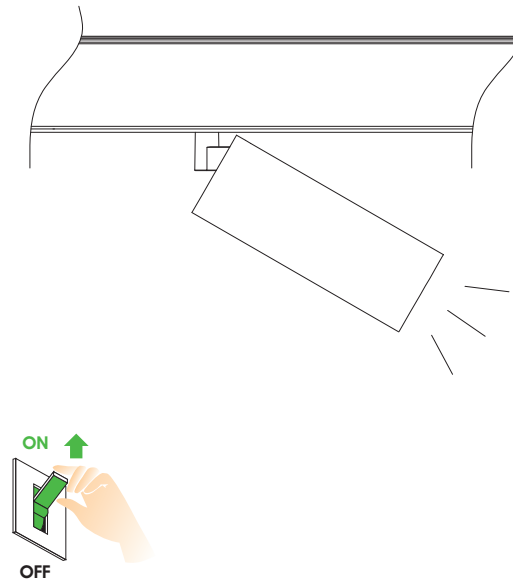

6

To uninstall make sure you first press the button

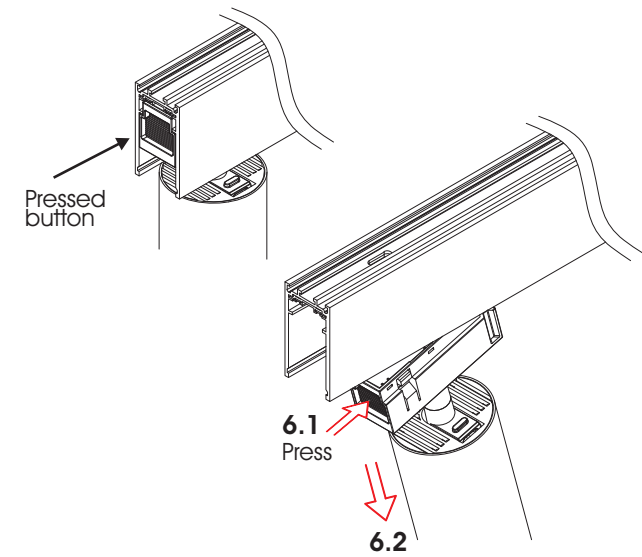



Warning:

Do not slide for any reason the Click it LED luminaire along the track regardless if the power is ON or OFF.
To adjust the position of the luminaire you need to **first take out** the luminaire of the track **and then relocate** it to the new position on the track.
Noncompliance with the above may permanently damage the luminaire.

